

The image shows a modern building with a blue facade. The word "KEPAQI" is written in large, white, bold, sans-serif capital letters on the right side of the building. The building has several windows, some of which are reflecting the sky and clouds. The sky is a mix of blue and white, suggesting a clear day with some light clouds.

WELCOME TO KEPAQI

COMPANY PROFILE

Nantong Great Tools Co., Ltd. is one professional company ,which specializing in the export trade of brushless tools and cable tools. We are committed to providing high-quality and reliable products to global customers, meeting the needs of different industries, and providing customers with one-stop procurement services and high-quality after-sales support. Our products have been exported to multiple countries and regions around the world, including Europe, South America, Southeast Asia, Middle East, Russia, etc

We have two major production base. Brands are KEPAQI and SanZu. We mainly produce brushless tools and some high-level quality cable tools. In addition, our company has established stable cooperative relationships with some well-known brand in the market. We are providing a variety of product choices and customization services.

"Integrity, innovation, cooperation, and win-win" is the company's business philosophy. "Customer First" is our company's service tenet. We have a rich experience in international trade and have one professional team. We are dedicated to providing you with the most satisfactory service and the highest quality tools. We are looking forward to working with you in the coming future days.



Sanzu has launched a series of strong, long-lasting, efficient, and safe lithium battery products for professional users. With professional experience in lithium battery tool production, keeping up with the times, constantly integrating high-tech into products, and continuously optimizing and updating manufacturing processes in the development process, adopting advanced automated production equipment, strict quality inspection and safety testing, we continuously strive for high-quality lithium battery tools for professionals in various industries.



SANZU CHARGING TECHNOLOGY

FAST CHARGING

When the temperature of a lithium battery is high, it is necessary to cool it first before starting charging. During the process of starting and charging, the Sanzu charger always maintains air circulation through the lithium battery. Make the battery cool while charging quickly, greatly reducing the time required for charging.

Sanzu specializes in designing chargers that communicate with the built-in chip of the battery throughout the entire charging process. Actively controlling current, voltage, and temperature to extend battery life.



Communication Management

Intelligent adjustment of charging based on battery status Matching brushless motors for excellent performance

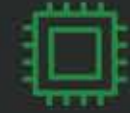

BMS management

Built in electronic protection technology for low power consumption Battery loosening, etc., in case of abnormal power outage Ensure that the machine does not run when power is restored



Battery protection

Full size shell protection structure, comprehensive protection Battery cell, sealant protected circuit board, anti leakage Anti impact, calmly handling harsh working conditions



thermal profile

TES energy storage materials, absorbing and storing battery dispersion Heat, balanced discharge temperature, prolonging battery life

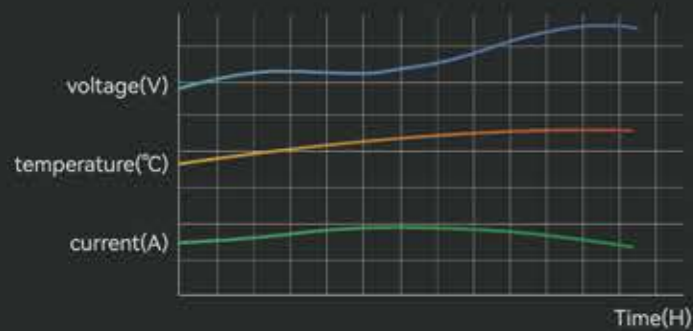

SZ-16-10/13

BRUSHLESS DRILL



Compact body with multi functions
Excellent drilling speed and operational capabilities

- Super vibration control technology
- Anti wear design of torque gear
- Variable speed, forward and reverse switch
- Premium wear-resistant button

Drill capacity(wood)

25mm



Drill capacity(steel)

10/13mm



Ultra-compact body: Easy to carry and comfortable to hold.

BRUSHLESS MOTOR **MAX. Torque 45N.m**



SPECIFICATIONS

SZ-16-10/13

Battery Voltage	16V
Battery Capacity	2.0Ah
Drilling Diameter	10/25mm
No-Load Speed	0-400/0-1400r/min
Maximum Torque	45N.m
Clamping Capacity	10/13mm
Net Weight	0.74Kg

SZ-21-10/13

BRUSHLESS DRILL



Compact body with multi functions

- 160mm impact body
- Variable dual speed setting
- Lightweight design
- Excellent drilling capability, strong torque
- Excellent drill bit clamping strength

Drill capacity(wood)

38mm



Drill capacity(steel)

10/13mm



160mm

240mm

Ultra-compact body: Easy to carry and comfortable to hold.

BRUSHLESS MOTOR **MAX. Torque 45N.m**



SPECIFICATIONS

SZ-21-10/13

Battery Voltage	21V
Battery Capacity	2.0Ah/4.0Ah
Drilling Diameter	10/38mm
No-Load Speed	0-450/0-1500r/min
Maximum Torque	45N.m
Clamping Capacity	10/13mm
Net Weight	0.81Kg

SZ-16-10C/13C

BRUSHLESS DRILL



Compact body with multi functions

Excellent drilling speed and operational capabilities

- Super vibration control technology
- Anti wear design of torque gear
- Variable speed, forward and reverse switch
- Premium wear-resistant button

Drill capacity(wood)
25mm



Drill capacity(steel)
10/13mm



Ultra-compact body: Easy to carry and comfortable to hold.

BRUSHLESS MOTOR MAX. Torque **45N.m**



SPECIFICATIONS

SZ-16-10C/13C

Battery Voltage	16V
Battery Capacity	2.0Ah
Drilling Diameter	10/25mm
No-Load Speed	0-400/0-1400r/min
Maximum Torque	45N.m
Clamping Capacity	10/13mm
Net Weight	0.77Kg

SZ-21-10C/13C

BRUSHLESS DRILL



20%
More Drilling Efficiency

20%
More Battery Life

Compact body with multi functions

Drill capacity(wood)
38mm

Drill capacity(steel)
10/13mm

- 160mm impact body
- Variable dual speed setting
- Lightweight design
- Excellent drilling capability, strong torque
- Excellent drill bit clamping strength

Ultra-compact body: Easy to carry and comfortable to hold.

BRUSHLESS MOTOR MAX. Torque **45N.m**



SPECIFICATIONS

S2-21-10C/13C

Battery Voltage	21V
Battery Capacity	2.0Ah/4.0Ah
Drilling Diameter	10/38mm
No-Load Speed	0-530/0-1840r/min
Maximum Torque	45N.m
Clamping Capacity	10/13mm
Net Weight	0.85Kg

SZ-16-7010/13

BRUSHLESS DRILL

34%
More Drilling Efficiency

15%
More Battery Life

Compact body with multi functions
Excellent drilling speed and operational capabilities



Drill capacity(wood)
42mm

Drill capacity(steel)
10/13mm

- Super vibration control technology
- Anti wear design of torque gear
- Variable speed, forward and reverse switch
- Premium wear-resistant button



Ultra-compact body: Easy to carry and comfortable to hold.

BRUSHLESS MOTOR **MAX. Torque 70N.m**

Li-ion 1850 r/min LASER CARVING 70 N.m

SPECIFICATIONS

SZ-16-7010/13

Battery Voltage	16V
Battery Capacity	2.0Ah
Drilling Diameter	10/42mm
No-Load Speed	0-500/0-1850r/min
Maximum Torque	70N.m
Clamping Capacity	10/13mm
Net Weight	0.92Kg

PROFESSIONAL BRUSHLESS MOTOR

The brushless motor manufactured by Sanzhu has eliminated carbon brushes, making the motor operate at a more constant temperature, more efficient, and with a longer lifespan. Longer, electronically controlled brushless motors effectively utilize power to match torque and speed, achieving full capacity. The constantly changing application demands

SZ-16-7010C/13C

BRUSHLESS DRILL

34%
More Drilling Efficiency

15%
More Battery Life

Compact body with multi functions
Excellent drilling speed and operational capabilities



- Super vibration control technology
- Anti wear design of torque gear
- Variable speed, forward and reverse switch
- Premium wear-resistant button



Drill capacity(wood)
42mm

Drill capacity(steel)
10/13mm

Ultra-compact body: Easy to carry and comfortable to hold.

BRUSHLESS MOTOR MAX. Torque **70N.m**



SPECIFICATIONS

SZ-16-7010/13C

Battery Voltage	16V
Battery Capacity	2.0Ah
Drilling Diameter	10/42mm
No-Load Speed	0-500/0-1850r/min
Maximum Torque	70N.m
Clamping Capacity	10/13mm
Net Weight	1.12Kg

SZ-21-9010/13

BRUSHLESS DRILL

42%
More Drilling Efficiency

20%
More Battery Life

Compact body with multi functions
Excellent drilling speed and operational capabilities



- Super vibration control technology
- Anti wear design of torque gear
- Variable speed, forward and reverse switch
- Premium wear-resistant button



Drill capacity(wood)
50mm

Drill capacity(steel)
10/13mm

Ultra-compact body: Easy to carry and comfortable to hold.

BRUSHLESS MOTOR MAX. Torque **90N.m**



SPECIFICATIONS

SZ-21-9010/13

Battery Voltage	21V
Battery Capacity	2.0Ah/4.0Ah
Drilling Diameter	10/50mm
No-Load Speed	0-460/0-1830r/min
Maximum Torque	90N.m
Clamping Capacity	10/13mm
Net Weight	1.13Kg

HIGH EFFICIENCY AND LOW CONSUMPTION

High concentricity, straight drilling, high-strength gearbox with dual bearing system, no deviation when tightening screws and drilling holes. From fragile wood to hard steel plates, simply adjust the appropriate torque to easily drill holes.

21V max BRUSHLESS DRILL

SZ-21-9010C/13C

BRUSHLESS DRILL

42%
More Drilling Efficiency

20%
More Battery Life

Compact body with multi functions



Drill capacity(wood)

50mm

Drill capacity(steel)

10/13mm

- 160mm impact body
- Variable dual speed setting
- Lightweight design
- Excellent drilling capability, strong torque
- High quality wear-resistant band impact gearbox

Ultra-compact body: Easy to carry and comfortable to hold.

BRUSHLESS MOTOR **MAX. Torque 90N.m**

Li-ion 1830 1830rpm LASER CARVING 90N.m

SPECIFICATIONS

SZ-21-9010C/13C

Battery Voltage	21V
Battery Capacity	2.0Ah/4.0Ah
Drilling Diameter	10/50mm
No-Load Speed	0-460/0-1830r/min
Maximum Torque	90N.m
Clamping Capacity	10/13mm
Net Weight	1.37Kg

SZ-1201

BRUSHLESS DRILL

20%
More Drilling Efficiency

15%
More Battery Life

Drill capacity(wood)
120mm

Drill capacity(steel)
10/13mm

Compact body with multi functions
Excellent drilling speed and operational capabilities



- Super vibration control technology
- Anti wear design of torque gear
- Variable speed, forward and reverse switch
- Premium wear-resistant button



Ultra-compact body: Easy to carry and comfortable to hold.



BRUSHLESS MOTOR MAX. Torque **120N.m**

SPECIFICATIONS	SZ-1201
Battery Voltage	21V
Battery Capacity	4.0Ah/6.0Ah/8.0Ah
Drilling Diameter	10/120mm
No-Load Speed	0-500/0-1800r/min
Maximum Torque	120N.m
Clamping Capacity	13mm
Net Weight	1.31Kg

SZ-1201C

BRUSHLESS DRILL

20%
More Drilling Efficiency

20%
More Battery Life

Drill capacity(wood)
120mm

Drill capacity(steel)
10/13mm

Compact body with multi functions



- 160mm impact body
- Variable dual speed setting
- Lightweight design
- Excellent drilling capability, strong torque
- Excellent drill bit clamping strength

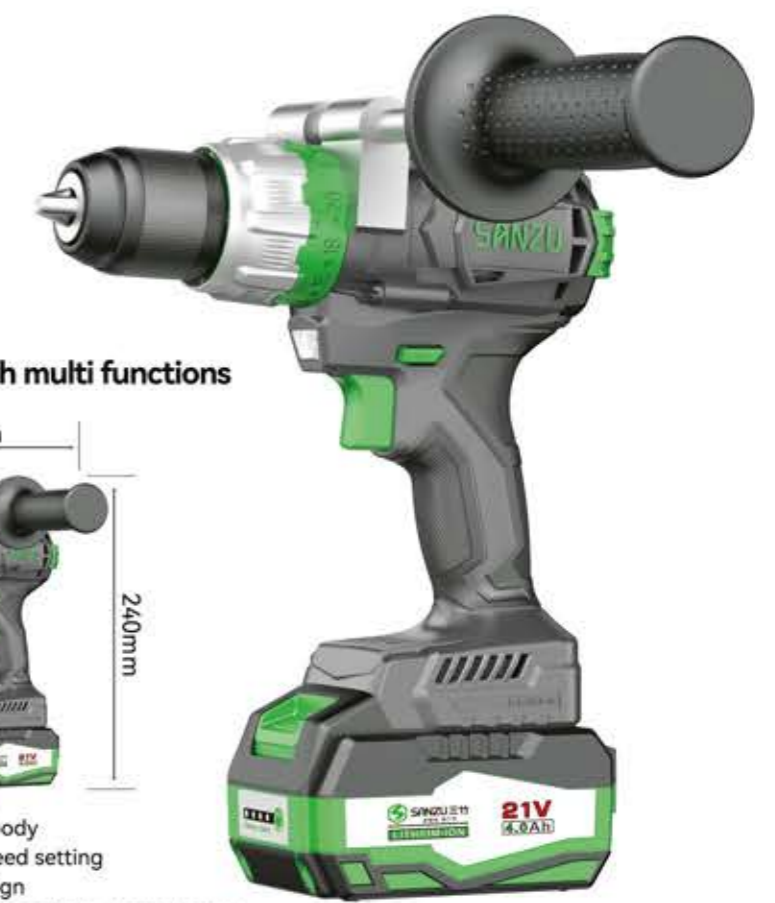

Ultra-compact body: Easy to carry and comfortable to hold.



BRUSHLESS MOTOR MAX. Torque **120N.m**

SPECIFICATIONS	SZ-1201C
Battery Voltage	21V
Battery Capacity	4.0Ah/6.0Ah/8.0Ah
Drilling Diameter	10/120mm
No-Load Speed	0-500/0-1800r/min
Maximum Torque	120N.m
Clamping Capacity	13mm
Net Weight	1.31Kg



160N.m
High strength/large quantity
Screwdriver/dovetail nail

SZ-1618
BRUSHLESS SCREW DRIVER

15%
More Tightening
Torque

15%
More Battery
Life

Maximum Torque
160N.m

Impact Frequency
3600bpm

- Hexagon chuck design
- Stable clamping LED lighting
- Not afraid of the dark and blind spots
- High-quality speed switch
- Gearbox is wear-resistant and durable
- Forward and reverse mode
- Compact body for access in tight spaces
- High-quality battery cells with long lifetime



Several easy-to-use working modes: easier screw tightening, adapt to different work needs.



**BRUSHLESS
MOTOR**

SPECIFICATIONS

SZ-1618

Battery voltage	16.8V
Battery capacity	2.0Ah
Clamping capacity	6.35mm
No-load speed	0-1500/2600/3200r/min
Maximum torque	160N.m
Impact Frequency	0-1900/3000/3600bpm
Net weight	0.73Kg



230N.m
High strength/large quantity
Screwdriver/dovetail nail

SZ-2123
BRUSHLESS SCREW DRIVER

15%
More Tightening
Torque

15%
More Battery
Life

Maximum Torque
230N.m

Impact Frequency
4500bpm

- Hexagon chuck design
- Stable clamping LED lighting
- Not afraid of the dark and blind spots
- High-quality speed switch
- Gearbox is wear-resistant and durable
- Forward and reverse mode
- Compact body for access in tight spaces
- High-quality battery cells with long lifetime



Several easy-to-use working modes: easier screw tightening, adapt to different work needs.



**BRUSHLESS
MOTOR**

SPECIFICATIONS	SZ-2123
Battery voltage	21V
Battery capacity	2.0Ah/4.0Ah
Clamping capacity	6.35mm
No-load speed	0-1800/2600/3300r/min
Maximum torque	160/180/230N.m
Impact Frequency	0-2300/2900/3700bpm
Net weight	0.9kg

EXTREMELY FAST DISASSEMBLY

torque to easily drill holes High concentricity, straight drilling, high-strength gearbox with dual bearing system, no deviation when tightening screws and drilling holes- From fragile wood to hard steel plates, simply adjust the appropriate



21V max BRUSHLESS IMPACT WRENCH

SZ-450

BRUSHLESS IMPACT WRENCH

25%
More Tightening
Torque

15%
More Battery
Life

Max. torque tightening
450N.m

Max. reversal torque
500N.m

IMPACT GEAR

In forward and reverse mode, you can choose high speed/low speed gears to adapt different materials or screws

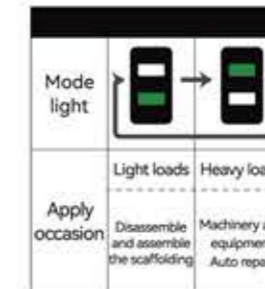

- High efficiency, brushless motor
- Rubber handles, handheld comfort
- Intelligent disassembly key
- 2-speed mode
- Very compact and well balanced



Several easy-to-use working modes: easier screw tightening, adapt to different work needs.



**BRUSHLESS
MOTOR**

SPECIFICATIONS

SZ-450

Battery voltage	21V
Battery capacity	4.0Ah/6.0Ah
Square tenon size	12.7(1/2)mm
No-load speed	0-2000/2500r/min
Maximum torque	250/450N.m
Impact Frequency	0-2400/2900bpm
Net weight	1.03kg

SZ-350

BRUSHLESS IMPACT WRENCH

20%
More Tightening
Torque

15%
More Battery
Life

Max. torque tightening
380N.m

Max.reversal torque
430N.m

IMPACT GEAR

In forward and reverse mode, you can choose high speed/low speed gears to adapt different materials or screws

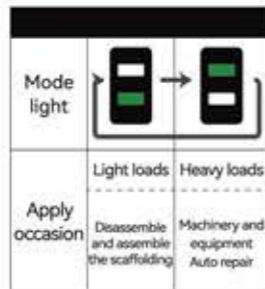

- High efficiency, brushless motor
- Rubber handles, handheld comfort
- Intelligent disassembly key
- 2-speed mode
- Very compact and well balanced



Several easy-to-use working modes: easier screw tightening, adapt to different work needs.



BRUSHLESS MOTOR

SPECIFICATIONS	SZ-350
Battery voltage	21V
Battery capacity	4.0Ah/6.0Ah
Square tenon size	12.7(1/2)mm
No-load speed	0-2100/2550r/min
Maximum torque	300/380N.m
Impact Frequency	0-2500/3200bpm
Net weight	1.11kg

SZ-650

BRUSHLESS IMPACT WRENCH

28%
More Tightening
Torque

15%
More Battery
Life

Max. torque tightening
650N.m

Max.reversal torque
700N.m

IMPACT GEAR

In forward and reverse mode, you can choose high speed/low speed gears to adapt different materials or screws

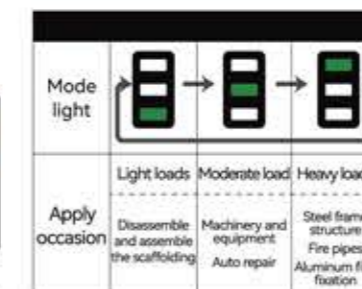

- High efficiency, brushless motor
- Rubber handles, handheld comfort
- Intelligent disassembly key
- 2-speed mode
- Very compact and well balanced



Several easy-to-use working modes: easier screw tightening, adapt to different work needs.



BRUSHLESS MOTOR

SPECIFICATIONS	SZ-650
Battery voltage	21V
Battery capacity	4.0Ah/6.0Ah
Square tenon size	12.7(1/2)mm
No-load speed	0-1750/2200/2600r/min
Maximum torque	300/450/650N.m
Impact Frequency	0-2100/2650/3000bpm
Net weight	1.15kg

MORE TORQUE

Strong torque, long-lasting endurance, three-gear adjustment, easy to cope with a variety of working conditions, simple operation, tungsten steel shaft, no deformation and no deviation.



21V max BRUSHLESS IMPACT WRENCH

SZ-898

BRUSHLESS IMPACT WRENCH

30%
More Tightening
Torque

15%
More Battery
Life

Max. torque tightening
950N.m

Max. reversal torque
1000N.m

IMPACT GEAR

In forward and reverse mode, you can choose high speed/low speed gears to adapt different materials or screws

Mode light			
Apply occasion	Light loads Disassemble and assemble the scaffolding	Moderate load Machinery and equipment Auto repair	Heavy loads Steel frame structure Fire pipes Aluminum film fixation

- High efficiency, brushless motor
- Rubber handles, handheld comfort
- Intelligent disassembly key
- 2-speed mode
- Very compact and well balanced



Several easy-to-use working modes: easier screw tightening, adapt to different work needs.



**BRUSHLESS
MOTOR**

SPECIFICATIONS

SZ-898

Battery voltage	21V
Battery capacity	4.0Ah/6.0Ah/8.0Ah
Square tenon size	12.7(1/2)mm
No-load speed	0-1800/2100/2400r/min
Maximum torque	700/800/1000N.m
Impact Frequency	0-2200/2500/3200bpm
Net weight	1.88kg

SZ-150

BRUSHLESS CIRCULAR SAW



32%
More Cutting
Efficiency

Blade diameter
150mm

15%
More Battery
Life

Adjustable angle
0-45°

- Soft start
- High quality metal base plate
- High quality lithium battery long lifetime
- Rubber handles, comfortable to hold
- High efficiency, Brushless motor

21V high-performance lithium battery and brushless motor, electronic braking

Li-ion 6300 rpm LASER CARVING

BRUSHLESS MOTOR MAX.Cutting depth **56mm**

SPECIFICATIONS

SZ-150

Battery voltage	21V
Battery capacity	4.0Ah/6.0Ah/8.0Ah
Blade diameter	150mm
Rated speed	6300r/min
Cutting depth	0-56mm
Angle adjustment	0-45°
Net weight	2.01kg

STRONGER CUTTING POWER

Electronic quick brake, quick brake with quick saw blade stop for maximum safety. The 0-45° chamfer capability allows for aggressive chamfer cutting in a wide range of applications.

SZ-140

BRUSHLESS CIRCULAR SAW



30%
More Cutting Efficiency

15%
More Battery Life

Blade diameter
140mm

Adjustable angle
0-45°

- Soft start
- High quality metal base plate
- High quality lithium battery long lifetime
- Rubber handles, comfortable to hold
- High efficiency, Brushless motor

21V high-performance lithium battery and brushless motor, electronic braking



BRUSHLESS MOTOR MAX.Cutting depth **51mm**

SPECIFICATIONS	SZ-140
Battery voltage	21V
Battery capacity	4.0Ah/6.0Ah/8.0Ah
Blade diameter	140mm
Rated speed	6300r/min
Cutting depth	0-51mm
Angle adjustment	0-45°
Net weight	1.91kg

SZ-165

BRUSHLESS CIRCULAR SAW



30%
More Cutting Efficiency

15%
More Battery Life

Blade diameter
165mm

Adjustable angle
0-45°

- Soft start
- High quality metal base plate
- High quality lithium battery long lifetime
- Rubber handles, comfortable to hold
- High efficiency, Brushless motor

21V high-performance lithium battery and brushless motor, electronic braking



BRUSHLESS MOTOR MAX.Cutting depth **59mm**

SPECIFICATIONS	SZ-165
Battery voltage	21V
Battery capacity	4.0Ah/6.0Ah/8.0Ah
Blade diameter	165mm
Rated speed	5000r/min
Cutting depth	0-59mm
Angle adjustment	0-45°
Net weight	2.01kg

1250r/min

Heavy-duty drilling is efficient and powerful, shoveling, chiseling, drilling, and drilling in every hole



21V max BRUSHLESS ROTARY HAMMER

SZ-26

BRUSHLESS ROTARY HAMMER



- Rotary hammer and demolition hammer
- Dust and shock
- Brushless motor
- Safety clutch protection

15%
More Drilling
Efficiency

18%
More Battery
Life

Impact ability
3.1J

21V high-performance lithium battery and brushless motor, double shock absorption



BRUSHLESS MOTOR
MAX. Drilling dia.
26mm

SPECIFICATIONS

SZ-26

Battery voltage	21V
Battery capacity	4.0Ah/6.0Ah/8.0Ah
Drilling capacity	26mm
Rated speed	1250r/min
Impact capacity	3.1J
Impact frequency	5200bpm
Net weight	1.76kg

SZ-28

BRUSHLESS ROTARY HAMMER



- Rotary hammer and demolition hammer
- Dust and shock
- Brushless motor
- Safety clutch protection

15%
More Drilling
Efficiency

20%
More Battery
Life

Impact ability
3.5J

21V high-performance lithium battery and brushless motor, double shock absorption



BRUSHLESS MOTOR MAX.Drilling dia. **28mm**

SPECIFICATIONS

SZ-28

Battery voltage	21V
Battery capacity	4.0Ah/6.0Ah/8.0Ah
Drilling capacity	28mm
Rated speed	900r/min
Impact capacity	3.5J
Impact frequency	4500bpm
Net weight	4.28kg

SZ-20

BRUSHLESS ROTARY HAMMER



- Rotary hammer and demolition hammer
- Dust and shock
- Brushless motor
- Safety clutch protection

10%
More Drilling
Efficiency

10%
More Battery
Life

Impact ability
2.0J

21V high-performance lithium battery and brushless motor, Strong power



BRUSHLESS MOTOR MAX.Drilling dia. **20mm**

SPECIFICATIONS

SZ-20

Battery voltage	21V
Battery capacity	4.0Ah/6.0Ah/8.0Ah
Drilling capacity	20mm
Rated speed	1400r/min
Impact capacity	2.0J
Impact frequency	4500bpm
Net weight	1.76kg

8300r/min

High efficiency grinding and cutting, long-lasting endurance, high speed and strong power



21V max BRUSHLESS ANGLE GRINDER

SZ-100/125 BRUSHLESS ANGLE GRINDER

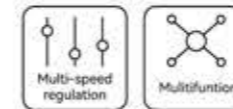

- Brushless motor, efficient and durable
- All-metal protective cover, safe and secure
- Cycle heat dissipation, long-lasting cutting
- Cutting, grinding, polishing
- Compact body, lightweight and portable

The motor housing is slim and provides excellent maneuverability, user can operate it by holding the handle and the body.



25%
More Cutting
Efficiency

MAX.rated speed
8300r/min

15%
More Battery
Life

Spindle thread
M10/M14

**BRUSHLESS
MOTOR** Hole dia. of wheel
16/22.2mm

SPECIFICATIONS

SZ-100/125

Battery voltage	21V
Battery capacity	4.0Ah/6.0Ah/8.0Ah
Grinding wheel diameter	100/125mm
Rated speed	3200/8300r/min
Spindle thread	M10/M14
Hole Dia. of Wheel	16/22.2mm
Net weight	1.28kg

SZ-21A

BRUSHLESS METAL SHEAR

20%
Shearing capacity

15%
More Battery Life



Cutting ability(Iron)
1.5mm

Cutting ability(aluminium)
1.6mm

Easily cut metal on top of a machine with multiple people

- Industrial chrome vanadium steel alloy blade
- Cuts metal sheets in seconds without jamming
- The cut is smooth and burr-free
- It is more convenient to use both straight and curved shears
- Stable control of shearing without deviation

Ultra-compact body: Easy to carry and comfortable to hold.

BRUSHLESS MOTOR **FREQUENCY 2400**

Li-ion 2400 rpm LASER CARVING

SPECIFICATIONS	SZ-21A
Battery voltage	21V
Battery capacity	2.0Ah
Shear frequency	0-2400r/min
Cutting ability	Iron plate (1.5mm) Aluminium plate (1.6mm) Stainless steel plate (0.5mm)
Net weight	1.23kg

SZ-30

BRUSHLESS PRUNING SHEAR

23%
Shearing capacity

18%
More Battery Life



Trimming range(Dry branches)
20mm

Trimming range(Wet branches)
30mm

Brushless power for easy pruning
Low wear, higher efficiency, lower energy consumption, more stable

- Clutch safety switch
- Ergonomic handle design, comfortable to hold
- Strong power effectively improves work efficiency
- Safety protection switch Automatic shutdown function
- Intelligent opening adjustment can easily solve 0-5CM branches

Ultra-compact body: Easy to carry and comfortable to hold.

BRUSHLESS MOTOR

Li-ion LASER CARVING 30 Nm

SPECIFICATIONS	SZ-30
Battery voltage	21V
Battery capacity	2.0Ah
Trimming range	0-20/0-30mm
Net weight	0.71kg

5200r/min

Light and powerful, efficient sawing, professional logging
The choice of experts



21V max BRUSHLESS CHAIN SAW

SZ-318 BRUSHLESS CHAIN SAW



- Long working time
- Electronic safety lock
- Stepless speed switch
- Fully automatic oil pump lubricates the chain
- Mechanical and electronic safety brakes, double protection
- Comfortable soft rubber handle, easy to operate
- Low noise, very suitable for use in noise-sensitive areas
- SDS tool-free quick adjustment system

15%
Improved
efficiency

Knife guide
12"/16"

20%
More Battery
Life

Cutting diameter
280mm

21V high-performance lithium battery and brushless motor,
Flexible and free, do as you like, logging is easier

Li-ion 5200 r/min LASER CARVING

**BRUSHLESS
MOTOR**

SPECIFICATIONS

SZ-318

Battery voltage	21V
Battery capacity	8.0Ah
Rated speed	5200r/min
Guide plate length	355mm
Cutting diameter	280mm



ONE PLATFORM FOR MULTI-MACHINE SHARING

Combine Whatever You Want gives you unlimited flexibility in choosing tools, batteries, and chargers, saving costs, while truly buying only what you need



Power-off Protection, Safety Assurance



Real-time monitoring, control discharge



ONE PLATFORM FOR MULTI-MACHINE SHARING

Combine Whatever You Want gives you unlimited flexibility in choosing tools, batteries, and chargers, saving costs, while truly buying only what you need



Power-off Protection, Safety Assurance



Real-time monitoring, control discharge